

● Feature 特性

- ★ OSC2016 4pin贴片晶振、晶体谐振器
- ★ 满足无铅焊接的回流温度曲线要求
- ★ 高精度、高频率稳定性、可靠性
- ★ 低功耗、低抖动
- ★ 降低电磁干扰 (EMI) 影响
- ★ 优良的耐环境特性, 可达工业级温度
- ★ 包装: 编带卷, 3000pcs/卷



型号	Holder Type	OSC 3225
频率范围	Frequency Range	1.250MHz~80.000MHz
频率偏差	Frequency Toleranc (ΔF) at25°C	±20ppm~±30ppm
输入电压	Supply Voltage	1.8V~5.0V ±10%
工作温度范围	Operating Temperature Range	-20°C~+70°C to -40°C~+85°C
储存温度范围	Storage Temperature Range	-20°C~+60°C to -55°C~+125°C
占空比	Symmetry	40/60 Standald
输出	Output Load 5.0V	10 TTL or 15pF HCMOS
	Output Load 2.0V	10 TTL or 15pF HCMOS
消耗电流	Current Consumption 5.0V	1-36MHz=15mA Max
		36-50MHz=20mA Max
	Current Consumption 2.0V	1-36MHz=10mA Max
		36-50MHz=15mA Max
上升/下降时间	Rise/fall Time	10nS Max

● Mechanical Dimensions 外型尺寸

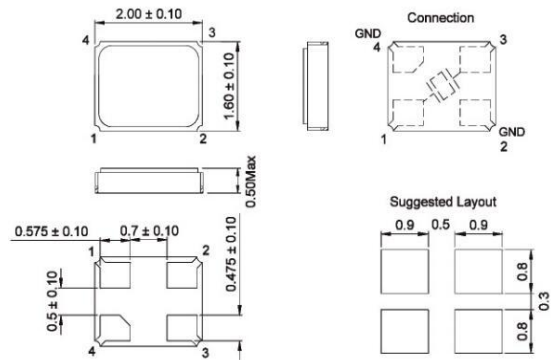

● Test Circuit 测试电路

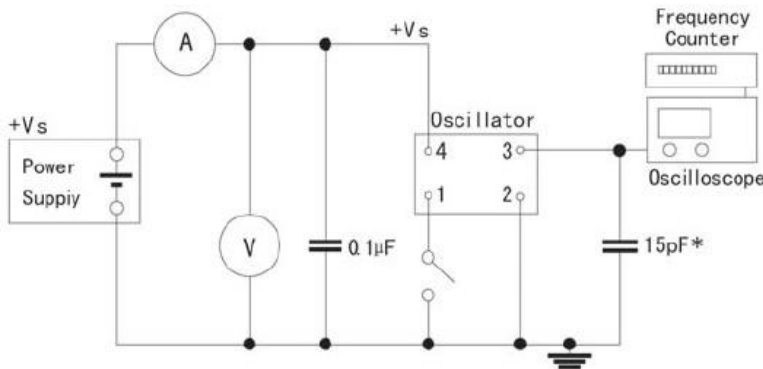

PIN	FUNCTION
1	N/C or Tri-state
2	Ground
3	Output
4	Vdd

● Reflow condition 回流焊条件

